

PRODUCT CATALOG

2023

RETAIL PRICING



This Catalog is Interactive!

- Click on any product in the index below to go to the corresponding product page
- To return to this page simply click on the PFI logo at the bottom of any page

Index

Coolers _____ **03**

- [Iceman I](#) >
- [Iceman II](#) >
- [Retro Cooler](#) >
- [Counter Server](#) >
- [Polar Endcap](#) >
- [Nostalgia Cooler](#) >
- [Contemporary Cooler](#) >

End Aisle _____ **06**

- [Versa Tower Station](#) >
- [Versa Tower Sub-Station](#) >
- [Versa Tower Power Station](#) >
- [Power Tower](#) >
- [Power Tower Accessories](#) >
- [Metawood Endcap](#) >
- [Georgetown Station](#) >

Fast Lane Merchandising _____ **11**

- [Intelli-Glide FLM Topper](#) >
- [FLM Wingman](#) >
- [Visi-Cooler Can Roller](#) >
- [The Organizer](#) >
- [Visi-Cooler Spacemaker](#) >

Gravity Wire Racks _____ **14**

- [Slimline Gravity](#) >
- [Metal Superglide](#) >

Wire Racks _____ **16**

- [Foldout \(Foldout, Premium Foldout, Mini Foldout\)](#) >
- [Cyclone](#) >
- [Everyday Rack](#) >
- [Hotwire](#) >
- [Multi-Flex Mini](#) >
- [HiRise I, II, III, IV](#) >
- [Triple Play Wingman](#) >
- [Flex Wingman](#) >
- [Countertop Can Roller](#) >
- [Hanging Can Roller](#) >

Plastic Racks _____ **22**

- [Showoff Spacesaver](#) >
- [Showoff III](#) >
- [Showoff IV](#) >
- [Showoff I](#) >
- [Showoff II](#) >
- [Showoff Half Round](#) >

Wood Racks _____ **23**

- [Georgetown Rovers](#) >
- [Wingmate Bumpout](#) >
- [Wingmate Bunker](#) >
- [Wingmate Tall](#) >
- [Basket Rack](#) >

Pallet Displays _____ **25**

- [4x4 Metal H-Racks](#) >
- [3x3 Metal H-Racks](#) >
- [2x4 Metal H-Racks](#) >
- [Produce Dump Bin](#) >
- [Profit Table Cube Island](#) >

Bases and Bins _____ **27**

- [Promo Platform](#) >
- [Iceman I Dump Bin](#) >
- [Wire Dump Bin](#) >

Cold Vault Merchandising _____ **29**

- [Cool Glide 20/20](#) >
- [Intelli-Glide](#) >
- [Modular Glide](#) >
- [Can Rollers](#) >
- [Spacemaker](#) >

Gondola Merchandising _____ **31**

- [Ultra-Glides](#) >
- [Super Ultra-Glides](#) >

Recycling _____ **33**

- [PET Recycle Bottle](#) >

Corrugated Displays _____ **34**

- [Showoff Spectacular](#) >
- [3 & 4-Shelf Case Merchandisers](#) >
- [Case Sleeves](#) >
- [Dump Bins](#) >
- [Case Stacker](#) >
- [Retail Standee](#) >

Suction Cup Cooler Door Displays _____ **37**

Inventory Management _____ **41**

- [C21 Cooler Shelving System](#) >
- [Stockmaster](#) >
- [Retail Shelving](#) >
- [Bag-In-Box Stockmaster](#) >
- [Stockmaster IMC Cart](#) >
- [RBC Shelving](#) >

Acrylic Displays _____ **44**

Terms & Conditions

All pricing is subject to change without notice. Many of the product merchandising units displayed herein are protected by US and Foreign Patents and other patents pending. The various products, product graphics and product trademarks are the property of the various companies whose products are displayed herein. Visuals subject to change. Please call for available graphics, minimum quantities and lead time. Pricing dependent on changes in market conditions. Pricing does not include additional customer markups. ©2023 Presence From Innovation (PFI), LLC / Jahabow, LLC / Butler Merchandising Solutions, LLC / Exactec, LLC (PFI/Jahabow/Butler/Exactec are divisions of PFI Holding Company, LLC) All rights reserved. Effective 01/01/2023.

Add \$1.00 per label to price for carton labels if required.

Contact PFI Sales for blank carton fees.

Featured Products



Iceman® II



Everyday Rack



Countertop Can Roller



ICEMAN® I BARREL COOLERS



Description:

- 3 variations for your merchandising needs:
 - **Iceman I** is the workhorse that maximizes brand exposure
 - **Premium Iceman I** features a colored lid and lid decal
 - **Iceman 3-In-1** features three graphic sections for merchandising different brands on one unit
- Integrated handle in lid and hinge can stay open if needed
- Deep reservoir for holding product
- Includes lid and wheels
- Guaranteed leak proof drain system

		# Units:	Pricing:
		ICEMAN® I (1/CTN)	
Item:		50-99.....	\$104.95
SKU:		100-499.....	\$94.95
Iceman I		500-999.....	\$84.95
		1000+.....	\$79.95
*Pricing includes graphics			

Dimensions & Packout:

23" Dia x 36" H
 Packs out (per unit) **144** 12oz cans, **76** 20oz bottles, **40** 1L bottles



Iceman 3-In-1



Header Graphic



Partitioned Divider

OPTIONS FOR ICEMAN COOLERS

Item:	SKU:	Price:
Iceman 3-In-1	xxx20201	\$15.00/extra
Premium Iceman I	xxx22221X	\$5.00/extra
Header Graphic	xxx22292	\$10.00/extra
Reservoir Insert	IM01-1179-2	\$5.00/extra
Partitioned 2-Way Divider*	IM01-7290-DIV	\$9.00/extra
Partitioned 3-Way Divider*	MNO22293	\$12.00/extra
‡1000 unit minimum		
*Includes reservoir insert		

REPLACEMENT GRAPHICS*

Graphics for:	SKU:	Graphics Pricing:
Iceman I	xxx29001	1-499 units..... \$25.00
Iceman 3-In-1	xxx21044	500+ units..... \$22.50

*Replacement graphics ship bulk packed

ACCESSORIES FOR ICEMAN COOLERS

Item:	SKU:	Price:
Snack Basket	MNO22291	\$32.50
Replacement Lids	MNO29028-16	\$25.00



Snack Basket

Click the logo to return to index page ▶



ICEMAN® II BARREL COOLERS



Iceman II

Description:

- Slim Cooler design is perfect for slim cans and similar package sizes
- Clear lid and wheels
- Guaranteed leak-proof drain system
- Improved weather durability

		# Units:	Pricing:
ICEMAN® II (1/GTN)		1-49.....	\$139.95
		50-99.....	\$109.95
		100-499.....	\$99.95
		500-999.....	\$89.95
		1000+.....	\$84.95
		<i>*Pricing includes graphics</i>	

Dimensions & Packout:

16" Dia x 33.5" H
 Packs out (per unit) **88** 8oz cans, **30** 20oz bottles

REPLACEMENT GRAPHICS*		Graphics Pricing:
Graphics for:	SKU:	1-499 units.....
Iceman II	xxx29002	\$25.00
		500+ units.....
		\$22.50
<i>*Replacement graphics ship bulk packed</i>		

RETRO COOLER



Retro Cooler

Description:

- Retro metal cooler boasts a vintage look to win over single-serve impulse purchases
- Bottle opener attached to front compartment
- Interchangeable graphics
- Wheels included

RETRO COOLER (1/GTN)		
Item:	SKU:	Price:
Retro Cooler	xxx51020	Call For Quote

**327 unit minimum*

Dimensions & Packout:

17.5" W x 22"D x 30" H (43" H with lid open)
 Packs out (per unit) **2-3** cases of 12oz glass or 20oz bottles

[Click the logo to return to index page](#) ▶



COUNTER SERVER



Description:

- Increase sales at checkout
- Four-sided graphic placement + select from permanent decals or interchangeable panels
- Easily empties melted ice

COUNTER SERVER COOLER (4/CTN)		
SKU: xxx29002	Dimensions: 18.5" D x 12.5" D x 4.5" H	Price: Call For Quote

*360 unit minimum

POLAR END CAP



Description:

- Seamlessly integrates beverage promotions both indoors and outdoors
- Includes front graphic channels and wheels (graphics are an additional charge)
- Optional partition sorts brands into 2 bins.
- Unit ships assembled.

POLAR END CAP COOLER (1/CTN)		
SKU: xxx45050	Dimensions: 32.5" D x 24.5" D x 37" H	Price: \$525.00*/each

*100 unit minimum

NOSTALGIA COOLER



Description:

- Retro vending machine facade with clear lid captivates customers' interests
- Guaranteed leak-proof drain system
- Includes wheels

NOSTALGIA COOLER (1/CTN)		
SKU: xxx44513	Dimensions: 20" D x 16" D x 38" H	Price: Call For Quote

*300 unit minimum

CONTEMPORARY COOLER



Description:

- Lid features integrated handle and can be die cut to create an opening for easier access
- Guaranteed leak-proof drain system
- Includes wheels

CONTEMPORARY COOLER (1/CTN)		
SKU: xxx44510	Dimensions: 20" D x 16" D x 38" H	Price: Call For Quote

*300 unit minimum

[Click the logo to return to index page](#) ▶



For more information or to place an order contact Customer Service: 800-325-2823
4847 Park 370 Blvd. Hazelwood, MO 63042 • PFIinnovation.com

VERSA TOWER STATION

#1 Selling End Cap in the Industry



Metal Versa Tower Station

Description:

- Versa Tower Station is a permanent end aisle solution that can be complemented with wood accents for a premium look
- Versa Tower Sub-Station features all the same benefits as standard VTS in a narrower footprint
- New & improved structure accepts optional base finishing kit and universal side shelves
- Graphics can be quickly changed
- Interior shelves can be set flat or gravity, wing shelves are perfect to merchandise transaction packs
- Assembles in less than 30 minutes and can be easily moved while fully loaded with a pallet jack

VERSA TOWER STATION (VTS) (1/SKID)

Item:	SKU:	Price:
A. Versa Tower Station w/ metal header	xxx59377	\$1,500.00/each
B. Versa Tower Station w/ wood header	xxx59377-WHDR	\$1,720.00/each
C. Versa Tower Station w/ wood header, wood fronts, wire side shelves	xxx59377-MTSS	\$1,775.00/each
D. Versa Tower Station w/ wood header, wood fronts and wood side shelves	xxx59377-W	\$2,024.00/each



Wood Versa Tower Station



Metal Versa Tower Sub-Station

Dimensions & Packout:

- A: 62.25" W x 38.75" D x 96.5" H
- B-D: 63.75" W x 41" D x 102" H
- Packs out (per unit) **50-60** cases of product

VERSA TOWER SUB-STATION (VTS-S) (1/SKID)

Item:	SKU:	Price:
E. Versa Tower Sub-Station	xxx59277	\$1,450.00/each

Dimensions & Packout:

- E: 62.25" W x 29.75" D x 96.5" H;
- Packs out (per unit) **35-45** cases of product

OPTIONS FOR VERSA TOWER STATION AND SUB-STATION

Item:	SKU:	Price:
Vertical Graphic Panels	xxx59916	\$65.00
Base Finishing Kit (VTS)	WR05-7324-KIT	\$90.00
Base Finishing Kit (VTS-S)	WR05-7324-KIT-27	\$90.00

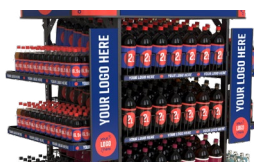

Vertical Graphic Panels



Base Finishing Kit

REPLACEMENT GRAPHIC KITS

Graphics For:	SKU:	Price:
Versa Tower Station*	xxx	\$70.00
Versa Tower Sub-Station*	xxx	\$70.00

*Includes header graphics, shelf logo strips and vertical graphics panel

Click the logo to return to index page ▶



VERSA TOWER POWER STATION



Versa Tower Power Station

Description:

- The Versa Tower Power Station is the end aisle solution when a smaller footprint is needed
- Perfect for grocery and drug/value stores
- Center shelves can be removed to accommodate a GDM Cooler (purchased separately)
- Side shelves are the same as those featured on the standard Versa Tower Sub-Station

VERSA TOWER POWER STATION (1/SKID)

Item:	SKU:	Price:
Versa Tower Power Station w/ adjustable dividers	xxx59885-ADJ	\$1,340.00/each
Versa Tower Power Station w/ fixed dividers	xxx59885-FIX	\$1,340.00/each

VERSA TOWER POWER STATION VISI-COOLER CONFIGURATION (1/SKID)

Item:	SKU:	Price:
Versa Tower Power Station Visi-Cooler Configuration w/ adjustable dividers	xxx59885-IADJ	\$1,130.00/each
Versa Tower Power Station Visi-Cooler Configuration w/ fixed dividers	xxx59885-IFIX	\$1,130.00/each



Versa Tower Power Station

Dimensions & Packout:

51" W x 29.75" D x 96.5" H
Packs out (per unit) **25-40** cases of product

REPLACEMENT GRAPHIC KITS

Graphics For:	SKU:	Price:
Versa Tower Power Station*	xxx	\$70.00

*Includes header graphics, shelf logo strips and vertical graphics panel

[Click the logo to return to index page](#) ▶



For more information or to place an order contact Customer Service: 800-325-2823
4847 Park 370 Blvd. Hazelwood, MO 63042 • PFIinnovation.com

POWER TOWERS



3x3 Power Tower Middle Section (A)

Description:

- Large format end aisle displays are ideal for merchandising multi-packs and mini cans
- Units can be joined together to form a large end cap
- Header wire for store graphics is included
- Side shelves available for both 24", 36" and 48" depths (each carton of side shelves includes 2 sets of shelf grids)
- 4 center shelves shipped with each unit
- **NEW** optional Adjustable Dividers for center shelves (for 36" and 48" Deep Units)

POWER TOWER SECTIONS (1/SKID)

Item:	SKU:	Price:
A. 3x3 Middle Section	MNO59263	\$950.00/each
B. 4x3 Middle Section	MNO59264	\$1,052.00/each
C. 3x4 Middle Section	MNO59260	\$1,030.00/each
D. 4x4 Middle Section	MNO59262	\$1,145.00/each
E. 4x2 Middle Section	MNO59261	\$892.00/each

Dimensions:

- A: 36.25" W x 37.25" D x 98" H
- B: 48.25" W x 37.25" D x 98" H
- C: 36.25" W x 49.25" D x 98" H
- D: 48.25" W x 49.25" D x 98" H
- E: 48.25" W x 25.25" D x 98" H



4x3 Power Tower Middle Section (B)



3x4 Power Tower Middle Section (C)

ADDITIONAL CENTER SHELVES (1/SKID)

Center Shelves For:	SKU:	Price:
3x3 Middle Section	MNO59293	\$175.00/each
4x3 Middle Section	MNO59294	\$193.00/each
3x4 Middle Section	MNO59290	\$207.00/each
4x4 Middle Section	MNO59292	\$240.00/each
4x2 Middle Section	MNO59291	\$155.00/each

ADJUSTABLE DIVIDERS FOR CENTER SHELVES (10/CNTN)

Dividers for:	SKU:	Price:
36" Deep Power Towers	WR05-8198-BX	\$60.00/ctn
48" Deep Power Towers	WR05-8199-BX	\$65.00/ctn



4x4 Power Tower Middle Section (D)



4x2 Power Tower Middle Section (E)

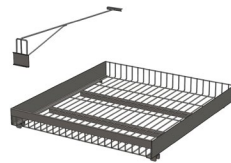

Adjustable Divider for Center Shelves

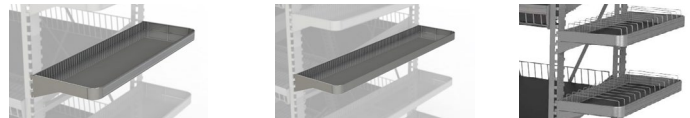

OPTIONAL SIDE SHELVES* (6/CNTN)

Item:	SKU:	Price:
36" Deep Side Shelves	MNO59293-SS	\$238.50/ctn
48" Deep Side Shelves	MNO59294-SS	\$260.50/ctn
24" Deep Side Shelves	MNO59291-SS	\$215.00/ctn

*2 sets of shelf grids ship with each carton of side shelves (far right picture above)

Click the logo to return to index page ▶



For more information or to place an order contact Customer Service: 800-325-2823
4847 Park 370 Blvd. Hazelwood, MO 63042 • PFIinnovation.com

POWER TOWER ACCESSORIES



Kit for 4' Wide units

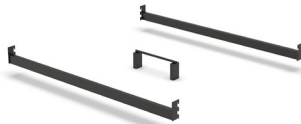
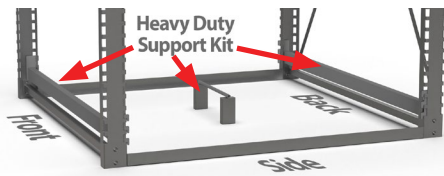

Kit for 3' Wide units



Description:

- Heavy-duty cross bars to increase the load capacity on the center bottom shelves to hold up to 1,400lbs.
- Available for 4x4, 4x3 and 3x4 units that could hold larger capacity on bottom shelf
- Price channel Replacement kit are also available with improved tape to adhere to the units

OPTIONAL POWER TOWER HEAVY DUTY KITS		
Item:	SKU:	Price:
Power Tower Bottom Shelf 4' Wide Kit	WR05-8408-KIT	\$100.00/ctn
Power Tower Bottom Shelf 3' Wide Kit	WR05-8409-KIT	\$15.00/ctn
Price Channel Replacement Kit	TBD	\$76.00/ctn

Price Channel Replacement

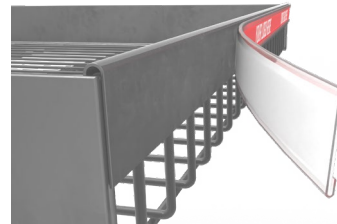

Apply adhesive back price channel to front of metal shelf



Price channel applied to front of metal shelf

Click the logo to return to index page ▶



METAWOOD ENDCAP



Metawood Endcap

Description:

- Removable wire grid sized to hold 2L bottles on shelves
- Includes header kit
- Front shelves and upper side shelves adjust from flat to gravity-feed
- Promotional channels on front and side shelves
- Wood grain vinyl header with magnetic attachment for header graphics
- Uprights are powder coated

METAWOOD ENDCAP (1/SKID)

Item: Metawood Endcap	SKU: xxx59568	Price: \$1,340.00 */each
---------------------------------	-------------------------	---

*25 unit minimum

OPTIONS FOR METAWOOD ENDCAP (1/CTN)

Item: Additional Center Shelf	SKU: WR05-7133-KITX	Price: \$135.00 */each
Additional Rear Shelf	WR05-7135-KITX	\$105.00 */each

*Min Order Required

Dimensions and Packout:

49.5" W x 38.75" D x 83.75" H
Packs out (per unit) **40-50** cases of product

GEORGETOWN STATION



GT Station 10



GT Station 6



GT Station 12

Description:

- Permanent equipment for end cap and check lane placements
- Center section holds a cooler (purchased separately)
- Shelving ideal for bulk and single serve packages
- All shelves vertically adjustable in 1.25" increments
- Permanent price channels on every shelf
- Ships assembled

GEORGETOWN STATIONS (1/SKID)

Item: A. Georgetown Station 6	SKU: xxx61081	Price: \$785.00 */each
B. Georgetown Station 10	xxx61082	\$750.00 */each
c. Georgetown Station 12	xxx61083	\$975.00 */each

Available in these colors:

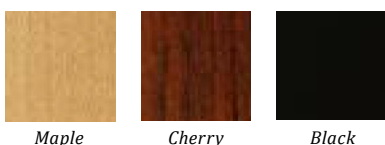

Maple

Cherry

Black

Dimensions:

- A: 44" W x 28.75" D x 54" H
- B: 44" W x 28.75" D x 60" H
- C: 48" W x 28.75" D x 84" H

Click the logo to return to index page ▶



INTELLI-GLIDE FLM TOPPER



Intelli-Glide FLM Topper 24" W

Intelli-Glide FLM Topper 36" W

Description:

- Capitalize on the space above any Visi-Cooler
- Angled unit ensures products properly fronted
- Adjustable dividers fit most any package size
- Magnetic cooler attachment
- Clear front product stop
- Features side panel and front channel graphics
- 2 widths available: 24" and 36"

INTELLI-GLIDE FLM TOPPERS (2/CTN)		
Item:	SKU:	Price:
A. Intelli-Glide FLM Topper 24" W	xxx50100	\$146.00/ctn \$73.00/each
B. Intelli-Glide FLM Topper 36" W	xxx50200	\$206.00/ctn \$103.00/each

Dimensions & Packout:

A: 23.75" W x 20" D x 6.5" H
 Packs out (per unit) **42** 20oz bottles, **56** 12oz/16oz cans, **35** 1L bottles
 B: 35.75" W x 20" D x 6.5" H
 Packs out (per unit) **66** 20oz bottles, **84** 12oz/16oz cans, **50** 1L bottles

FLM WINGMAN



Description:

- Seamlessly converts a GDM cooler into endcap
- Fits a variety of package sizes with adjustable side shelves
- Ships with 10 side shelves
- Visi-Cooler purchased separately

FLM WINGMAN (1/CTN)		
Item:	SKU:	Price:
FLM Wingman	xxx54780-10SS	Call For Quote

*100 unit minimum

Dimensions & Packout:

42.5" W x 29.5" D x 53.5" H
 Packs out (per shelf) **18** 20oz bottles and **3** 16.9oz multi-packs

[Click the logo to return to index page](#) ▶



VISI-COOLER CAN ROLLER

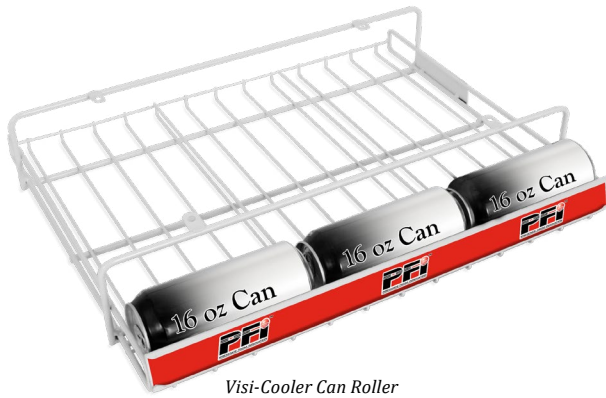

Visi-Cooler Can Roller

Description:

- Profit from additional products by maximizing vertical space in Visi-Coolers
- Gravity feed single serve drinks
- 2 fixed dividers
- Front graphic strip

VISI-COOLER CAN ROLLER (1/CTN)		
Item: Visi-Cooler Can Roller	SKU: MNO13957	Price: \$57.50/each
Visi-Cooler Can Roller w/ graphics	xxx13957	

*120 unit minimum

Dimensions & Packout:

19.75" W x 16.25" D
Packs out (per unit) **15** 12oz cans and **15** 16oz cans

THE ORGANIZER



Description:

- Organizes product on flat shelf in Visi-Cooler
- Ventilated floors promote air flow to keep product cooled
- Fixed channel grooves for 20oz bottles and 16oz cans
- Ships 10 per carton and in one-piece

THE ORGANIZER (10/CTN)		
Item: Flat Shelf Organizer for Visi-Cooler	SKU: MNO11085	Price: \$115.00/ctn \$11.50/each

Dimensions & Packout:

21.25" W x 17.75" D x 2" H
Packs out (per unit) **30** 20oz bottles

VISI-COOLER SPACEMAKER



Description:

- Insert additional shelf to gain vertical space in your existing FLM Coolers
- Adds approximately 35, 20oz bottles per shelf
- Adjustable width and depth
- Ships 6 per carton

VISI-COOLER SPACEMAKER (6/CTN)		
Item: Visi-Cooler Spacemaker	SKU: MNO13930	Price: \$215.70/ctn \$35.95/each

*100 unit minimum

Dimensions:

16"-26" W x 17"-23" D

[Click the logo to return to index page](#) ▶



SLIMLINE GRAVITY RACKS



Slimline Gravity I



Slimline Gravity II



Slimline Gravity III



Slimline Gravity IV

Description:

- 4 versions available:
 - **Slimline Gravity I** - For tall, 1L slim bottles
 - **Slimline Gravity II** - For 2L or 64oz bottles
 - **Slimline Gravity III** - 3 wide unit for 20oz, 16.9oz and similar bottles
 - **Slimline Gravity IV** - 3 wide unit for 1L bottles
- Eye catching slim units ideal merchandiser for high profit, single serve beverages
- Small footprint units can be placed anywhere in the store
- Interchangeable large side panels allow for continual refreshing of brand messaging
- Tubular steel and wire construction
- Optional casters

SLIMLINE GRAVITY WIRE RACKS (1/CTN)

Item:	SKU:	Price:
A. Slimline Gravity I	xxx21400	\$244.40/each
B. Slimline Gravity II	xxx21410	\$252.75*/each
C. Slimline Gravity III	xxx21420	\$260.95*/each
D. Slimline Gravity IV	xxx21430	\$266.95/each

*100 unit minimum on Slimline II & III

Dimensions & Packout:

- A:** 11.25" W x 21.75" D x 53.5" H
Packs out (per unit) **56** 1L bottles
- B:** 13.75" W x 21.75" D x 54" H
Packs out (per unit) **32** 64oz bottles and **32** 2L bottles
- C:** 13" W x 22" D x 54.5" H
Packs out (per unit) **120** 18.5oz bottles and **105** 20oz bottles
- D:** 15" W x 22.5" D x 54.5" H
Packs out (per unit) **135** 1L bottles

OPTIONS FOR SLIMLINE GRAVITY WIRE RACKS

Item:	SKU:	Price:
Casters	Add W-18 to item #	\$15.30/addtl
Replacement Graphics (1/ctn) <i>for Slimline Gravity Racks</i>	WR01-7448-xxxB	\$30.00/each



Casters for Slimline Gravity Racks

Click the logo to return to index page ▶



METAL SUPERGLIDE



Metal Superglide 4-Shelf Version



Metal Superglide 5-Shelf Version

Description:

- Merchandise fast-moving products throughout your store
- Four and five shelf configurations available
- Fixed 2L dividers and adjustable divider option available for all standard and mini configurations
- Adjustable dividers can be turned around to create a product stop
- Gravity-feed shelving converts to flat shelving when needed on all configurations
- Wheels are standard

METAL SUPERGLIDE WIRE RACKS (1/CTN)		
Item:	SKU:	Price:
A. Metal Superglide 4 Shelves w/ fixed dividers	xxx54600	\$374.95/each
B. Metal Superglide 4 Shelves w/ adjustable dividers	xxx54500	\$404.95/each
c. Metal Superglide 5 Shelves w/ fixed dividers	xxx54625	\$433.95/each

Dimensions & Packout:

A & B: 27.5" W x 29" D x 63.75" H (w/o header) 84.25" H (w/ header)
Packs out **30** 2L bottles per shelf

c: 27.5" W x 28.75" D x 79.5" H (w/o header) 100" H (w/ header)
Packs out **30** 2L bottles per shelf

OPTIONS FOR METAL SUPERGLIDES (1/CTN)			
Item:	SKU:	Dimensions:	Price:
Header	xxx	24.75" W x 15.5" H	\$16.50/each



Header for Metal Superglide

Click the logo to return to index page ▶



FOLDOUT RACKS



Foldout



Premium Foldout



Mini Foldout



Description:

- 3 variations for your merchandising needs:
 - **FOLDOUT** - is our versatile, high volume wire rack
 - **PREMIUM FOLDOUT** - an exceptional look with silver finish and added price channels
 - **MINI FOLDOUT** - is our smallest wire rack, perfect for easy placement
- Adjustable shelves
- Quick assembly!

FOLDOUT WIRE RACK (2/CTN)

Item:	SKU:	Price:
Foldout <i>no graphics</i>	MNO55265-BLK	\$228.60/ctn \$114.30/each
Foldout <i>w/ header</i>	xxx55265-BLK	\$246.50/ctn \$123.25/each
Foldout <i>w/ header and side panels</i>	xxx55265X-BLK	\$307.50/ctn \$153.75/each

Dimensions & Packout:

19" W x 14.25" D x 53" H; 71.5" H (with header)
Packs out (per shelf) **12** 2L bottles

PREMIUM FOLDOUT WIRE RACK (1/CTN)

Item:	SKU:	Price:
Premium Foldout <i>w/ header</i>	xxx55262X	\$146.70/each
Premium Foldout <i>w/ header and side panels</i>	xxx55262	\$176.70/each

Dimensions & Packout:

20" W x 15.75" D x 68.5" H
Packs out (per shelf) **12** 2L bottles, **24** 20oz bottles, **7** 24oz bottle 6-packs, **14** 7.5oz can 6-packs

MINI FOLDOUT WIRE RACK (1/CTN)

Item:	SKU:	Price:
Mini Foldout <i>no graphics</i>	MNO55267-BLK	\$79.60/each
Mini Foldout <i>w/ header</i>	xxx55267	\$90.10/each
Mini Foldout <i>w/ header and side panels</i>	xxx55267X	\$117.10/each

Dimensions:

12" W x 11.5" D x 41" H; 52.75" H (with header)

[Click the logo to return to index page](#) ▶



CYCLONE RACK



Description:

- 3 Variations for your merchandising needs:
 - **Cyclone I** for small beverage packages such as 8oz slim cans, 12oz cans etc.
 - **Cyclone II** for taller can beverages such as 16oz energy, 24oz beer etc.
 - **Cyclone III** for tall plastic packages such as 1L premium water, 28oz sports drinks also features removable top shelf.
- Racks ship partially assembled so you save on freight.
- New Design can be assembled in five minutes or less.
- Versatile and eye-catching racks with small footprint and a low price.
- Circular display adds value to any compact space in convenience stores, large and small formats and virtually any perimeter location.
- Easily change branded graphics.
- Fixed four shelf unit highlights single serve packs that generate incremental trial and consumption.
- Units ship assembled.
- Optional wheel base can be added to Cyclone I and II for increased mobility.



CYCLONE WIRE RACKS (1/CTN)		
Item:	SKU:	Price:
A. Cyclone I	xxx55601	\$222.50/each
B. Cyclone II	xxx55602	\$222.50/each
c. Cyclone III	xxx55603	\$231.50/each

Dimensions & Packout:

A & B: 16.5" Dia. x 61" H
 Packs out (per shelf) **21** 8oz cans, **15** 12oz & 16oz cans/bottles
c: 16.5" Dia. x 68.5" H
 Packs out (per shelf) **24** 16oz bottles, **16** 20oz bottles, **16** 1L bottles

OPTIONS FOR CYCLONE WIRE RACKS		
Item:	SKU:	Price:
Wheel Base (1/ctn)	MNO55690	\$39.00/ctn
Plastic Dump Bin (10/ctn)	MNO55693	\$35.00/ctn
Replacement Graphics (1/ctn)	WR03-7094-XXX	\$25.00/ctn



Click the logo to return to index page ▶



EVERYDAY RACK



Everyday Rack

Description:

- Ships with 5 shelves for greater merchandising flexibility.
- Super functional wire rack for merchandising trial products, single serve, multi-packs and more!
- Small format makes this display easy to place in store
- Shelves are adjustable to accommodate different packouts
- Includes header and shelf channel graphics; side panel graphics are optional
- Black finish
- Optional casters

EVERYDAY RACK (1/CTN)

Item:

Everyday Rack
w/ header graphics and shelf strips

SKU:

xxx55370X

Price:

\$186.50/each

Everyday Rack
w/ header graphics, shelf strips and side panels

xxx55370

\$197.00/each

Dimensions & Packout:

15.64" W x 10.85" D x 68.47" H

Packs out (per shelf) **12** 750ml bottles, **11** 28oz bottles, **20** 16oz cans/bottles, **4** 8 pack 12oz cans, **12** 1L bottles, **6** 2L bottles, **6** 10 pack mini cans

OPTIONS FOR EVERYDAY RACKS

Item:

Casters

SKU:

WR00-2754-KIT

Price:

\$15.00/each

[Click the logo to return to index page](#) ▶



For more information or to place an order contact Customer Service: 800-325-2823
4847 Park 370 Blvd. Hazelwood, MO 63042 • PFIinnovation.com

HOTWIRE RACK



Hotwire



Description:

- Hotwire Grid - side grid creates a 3D effect & allows for quick branding changes
- Eye catching tubular, wire rack for merchandising transaction packs and trial single serve beverages
- Ships with 4 adjustable shelves to accommodate multiple package sizes
- Changeable header, shelf strips and side panels

HOTWIRE WIRE RACKS (1/CTN)

Item:	SKU:	Price:
Hotwire w/ header, shelf strips & base graphics	xxx56100X	\$203.50/each
Hotwire w/ header, shelf strips, base graphics & side panels	xxx56100	\$215.95/each

Dimensions & Packout:

20.25" W x 17" D x 66.25" H (w/ header); 51" H (w/o header)
 Packs out (per shelf) **12** 2L bottles, **20** 1.5L bottles, **24** 20 oz bottles, **7** 6-pack 24oz bottles, **8** 8-pack 12oz bottles, **14** 6-pack 7.5oz cans

ACCESSORIES FOR HOTWIRE

Item:	SKU:	Price:
Casters	WR00-2750-KIT	\$12.45/set

MULTI-FLEX MINI RACK



Multi-Flex Mini
3-Shelf



Multi-Flex Mini
4-Shelf

Description:

- Units can be linked together to form a wall of product
- Vertically adjustable shelves
- Price channel and header graphics come standard, side panel graphics are optional
- 3-Shelf and 4-Shelf versions available

MULTI-FLEX MINI WIRE RACKS (1/CTN)

Item:	SKU:	Price:
Multi-Flex Mini 3-Shelf w/ wheels & header	xxx58026	\$289.95/each
Multi-Flex Mini 3-Shelf w/ wheels, header & side panels	xxx58026X	\$324.95/each
Multi-Flex Mini 4-Shelf w/ wheels & header	xxx58027	\$359.95/each
Multi-Flex Mini 4-Shelf w/ wheels, header & side panels	xxx58027X	\$394.95/each

Dimensions & Packout:

32.25" W x 19" D x 78.75" H
 Packs out (per shelf) **28** 2L bottles, **6** 12-pack cans

Click the logo to return to index page ▶



HIRISE RACKS



HiRise I



HiRise II

Description:

- 4 variations for your merchandising needs:
 - **HiRise I & II** - for wing placements
 - **HiRise III & IV** - for end aisle placements
- Six vertically adjustable shelves
- Accessory wing shelves can be added to the sides extending the width, 8" per wing shelf
- Not designed for use as free-standing units -- Must use included brackets to secure units to end cap or wing
- Units have base platform, gray finish and gray pegboard back insert

HIRISE WIRE RACKS (1/CTN)

Item:	SKU:	Price:
A. HiRise I	MNO58361-WG	\$385.00/each
B. HiRise II	MNO58360-WG	\$385.00/each
C. HiRise III	MNO58363-WG	\$514.00/each
D. HiRise IV	MNO58364-WG	\$636.00/each



HiRise III



HiRise IV

Dimensions & Packout:

- A:** 17" W x 13" D x 80" H
Packs out (per shelf) **5** 6-pack 7.5oz cans, **3** 8-pack 12oz bottles, **20** 18.5oz bottles, **12** 1L bottles, **6** 59oz bottles
- B:** 24" W x 13" D x 80" H
Packs out (per shelf) **7** 6-pack 7.5oz cans, **4** 8-pack 12oz bottles, **5** 6-pack 16.9oz bottles, **11** 2L bottles
- C:** 36" W x 13" D x 80" H
Packs out (per shelf) **11** 6-pack 7.5oz cans, **6** 8-pack 12oz bottles, **8** 6-pack 16.9oz bottles, **20** 2L bottles
- D:** 48" W x 13" D x 80" H
Packs out (per shelf) **16** 6-pack 7.5oz cans, **8** 8-pack 12oz bottles, **10** 6-pack 16.9oz bottles, **29** 2L bottles

ACCESSORIES FOR HIRISE RACKS

Item:	SKU:	Price:
Side Shelves (6/ctn)	WR01-7740-WG-BX	\$70.50/ctn



Side Shelves

[Click the logo to return to index page](#) ▶



For more information or to place an order contact Customer Service: 800-325-2823
4847 Park 370 Blvd. Hazelwood, MO 63042 • PFIinnovation.com

FLEX WINGMAN



Flex Wingman

Description:

- Compact unit that can attach to VTS, H-Rack displays or gondola shelving (brackets included)
- 5 adjustable shelves
- Available in black or gray

FLEX WINGMAN WIRE RACK (1/CTN)		
Item:	SKU:	Price:
Flex Wingman <i>no graphics</i>	MNO59219	\$109.50/each
Flex Wingman <i>w/ shelf strips</i>	xxx59219	\$114.50/each

Dimensions & Packout:

12.5" W x 7" D x 46.25" H

Packs out (per shelf) **10** 12oz slim cans, **40** 12oz slim can 4-packs

TRIPLE PLAY WINGMAN



Triple Play Wingman

Standing Base

Description:

- Compact merchandiser that can attach to gondola shelves or convert to free-standing unit with optional base
- 5-Shelf fixed configuration fits most package sizes
- Easily changeable graphics

TRIPLE PLAY WINGMAN WIRE RACK (1/CTN)		
Item:	SKU:	Price:
Triple Play Wingman	xxx58210	\$136.00/each

*100 unit minimum

OPTIONS FOR TRIPLE PLAY WINGMAN (1/CTN)		
Item:	SKU:	Price:
Standing Base	xxx58211	\$42.50*/each

*100 unit minimum

Dimensions & Packout:

18.25" W x 7" D x 46.25" H

Packs out **2.5** cases of product, **60** 20oz bottles and similar sized packaging

[Click the logo to return to index page](#) ▶



COUNTERTOP CAN ROLLER



Countertop Can Roller
Double Tier for 12oz Slim Cans



Countertop Can Roller
Double Tier for 12oz Cans

Description:

- Slim, small footprint wire can rollers for placement near checkout
- 3 Versions available:
 - Single Tier for 12oz cans
 - Double Tier for 12oz cans
 - Double Tier for 12oz slim cans - perfect for spotlighting multiple flavors
- Wire structure available in black, silver and white
- Ships with graphics

COUNTERTOP CAN ROLLER (1/CTN)		
Item:	SKU:	Price:
A. Countertop Can Roller <i>Double Tier for 12oz Cans</i>	xxx13995S	\$37.50/each
B. Countertop Can Roller <i>Double Tier for 12oz Slim Cans</i>	xxx13995	\$37.50/each
C. Countertop Can Roller <i>Single Tier for 12oz Cans</i>	TBD	\$37.50/each*

*250 unit minimum; 10-12 week lead times

Dimensions & Packout:

- A: 5.25" W x 8.4" D x 16.25" H
Packs out (per unit) **15** 12oz cans
- B: 6.5" W x 11 D x 16.75" H
Packs out (per unit) **17** 12oz slim cans
- C: 5.25" W x 8.4" D x 16.25" H
Packs out (per unit) **12** 12oz cans

HANGING CAN ROLLER



Hanging Can Roller

Description:

- Hanging can roller for slim cans
- Attaches to warehouse shelving and gondola shelving
- Front panel graphics
- Price channel and header graphics

HANGING CAN ROLLER (1/CTN)		
Item:	SKU:	Price:
Hanging Can Roller	xxx13993-BLK	\$65.00/each

Dimensions & Packout:

- 6.675" W x 5" D x 16.5" H
Packs out **8** 12oz slim cans



SHOWOFF RACKS



Showoff Spacesaver



Showoff III



Showoff IV



Showoff I



Showoff II



Showoff Half Round

Description:

- Showoff family of plastic racks provide a premium display at an economic price
- Multiple footprints available to suit most package sizes
- Manufactured from a combination of sustainable materials that can be recycled at the end of life
- Ask us about custom headers
- Available in 4-Shelf and 5-Shelf versions
- Available in these shelf colors:
- Clear poles
- Ships unassembled

SHOWOFF PLASTIC RACKS (1/CTN)

Item:	SKU:	Price:
A. Showoff Spacesaver 4-shelf w/ clear poles	xxx78000	\$75.95/each
B. Showoff III 4-Shelf w/ clear poles	xxx73000	\$77.95/each
C. Showoff IV 4-Shelf w/ clear poles and flat header	xxx74001	\$97.95*/each <small>*300 unit minimum</small>
D. Showoff I 4-Shelf w/ clear poles	xxx71000	\$119.95*/each <small>*200 unit minimum</small>
E. Showoff II 4-Shelf w/ clear poles	xxx72000	\$109.95*/each <small>*200 unit minimum</small>
F. Showoff Half Round 4-Shelf w/ clear poles	xxx70000	\$119.95*/each <small>*200 unit minimum</small>

Dimensions & Packout:

- A:** 18.75" W x 14" D x 48.25" H
Packs out (per shelf) **12** 2L bottles, **18** 1.5L bottles, **20** 1L bottles
- B:** 18.75" W x 18.75" D x 49.5" H (63" H with header)
Packs out (per shelf) **16** 2L bottles, **25** 1.5L bottles, **29** 1L bottles
- C:** 22" Dia. x 48" H (73.25" H with header)
Packs out (per shelf) **17** 2L bottles, **25** 1.5L bottles, **30** 1L bottles
- D:** 31.25" W x 18.75" D x 54" H
Packs out (per shelf) **24** 2L bottles, **37** 1.5L bottles, **40** 1L bottles
- E:** 29.75" W x 16.5" D x 63" H (with header)
Packs out (per shelf) **22** 2L bottles, **28** 1.5L bottles, **38** 1L bottles
- F:** 31.25" W x 18.75" D x 68" H (with header)
Packs out (per shelf) **21** 2L bottles, **32** 1.5L bottles, **35** 1L bottles



Small Showoff Flat Header



Mid-Sized Showoff Flat Header

HEADER OPTIONS (1/CTN)

Item:	SKU:	Price:
Small Showoff Flat Header For Showoff Spacesaver, III and IV	xxx79029	\$13.00/addtl
Mid-Sized Showoff Flat Header For Showoffs I, II and Half Round	xxx79003	\$17.00/addtl

Click the logo to return to index page ▶



GEORGETOWN ROVERS



Georgetown Rover 4-Shelf SM



Georgetown Rover Floor Seller

Description:

- 2 versions available:
 - **Georgetown Rover 4-Shelf** - wood rack with 4-shelves, price channels, side panel graphics and header
 - **Georgetown Rover Floor Seller** - low profile wood rack with 2-shelves, side panel graphics and price channels
- Fixed shelving tall enough for 2L bottles but versatile enough for all your plan-o-gram needs
- Natural, sustainable wood solution for premium placements anywhere in the store
- Available in Natural Honey stain

GEORGETOWN ROVER (1/CTN)		
Item:	SKU:	Price:
A. Georgetown Rover 4-Shelf SM w/ header	xxx60161-4SHDR-NTH	\$255.00/each
A. Georgetown Rover 4-Shelf SM w/header and wire grids	xxx60161X-4SHDR-NTH	\$289.00/each
B. Georgetown Rover Floor Seller	xxx60163-NTH	\$135.00/each

ACCESSORIES FOR GEORGETOWN ROVER 4-SHELF (4/CTN)		
Item:	SKU:	Price:
Wire Shelf Grid	WD01-8254-KIT	\$34.00/ctn \$8.50/each

Dimensions:

- A:** 22" W x 16.5" D x 51.25" H (74" H with header)
Packs out (per shelf) **12** 2L bottles, **20** 1L bottles, **9** 10-pack mini cans
- B:** 38" W x 12" D x 21.5" H
Packs out (per shelf) **16** 2L bottles, **30** 1L bottles, **36** 20oz bottles, **18** 10-pack mini cans

Click the logo to return to index page ▶



WINGMATE RACKS



Wingmate Bumpout



Wingmate Bunker



Wingmate Tall

Color Options Available:



Description:

- 3 versions available:
 - **Wingmate Bumpout** - low profile unit specifically designed for flush placements against open air coolers
 - **Wingmate Bunker** - designed for areas where low profiles are needed i.e. prepared food areas
 - **Wingmate Tall** - designed for wing placement or anywhere a shallow depth is needed
- Premium wood solutions, made in U.S.A.
- Permanent price channels
- Center shelves adjustable in 1.25" increments

WINGMATE WOOD RACKS (1/CTN)

Item:	SKU:	Price:
A. Wingmate Bumpout	xxx61172	\$215.00* /each
B. Wingmate Bunker (Black)	xxx61173	\$285.00* /each
Wingmate Bunker (Maple)	xxx61173-M	\$285.00* /each
Wingmate Bunker (Cherry)	xxx61173-C	\$320.00* /each
C. Wingmate Tall (Black)	xxx61174	\$360.00* /each
Wingmate Tall (Maple)	xxx61174-M	\$360.00* /each
Wingmate Tall (Cherry)	xxx61174-C	\$510.00* /each

*10 unit minimum

Dimensions:

- A: 35.5" W x 12.5" D x 32" H
- B: 35.75" W x 12.5" D x 32" H
- C: 35.75" W x 12.5" H x 54" H

BASKET RACK



Basket Rack

Description:

- Merchandise transaction packs with shopping baskets at the front of the store
- Premium wood solutions, made in U.S.A.
- Middle shelves adjustable in 1.25" increments

BASKET RACK (1/CTN)

Item:	SKU:	Price:
Walmart Basket Rack	MNO61210	\$350.00* /each
Walmart Basket Rack w/ Walmart vertical decal	xxx61211	\$400.00* /each

*10 unit minimum

Dimensions & Packout:

40.5" W x 13" D x 48" H
 Packs out **3** 8-pack 12oz bottles (top & bottom shelves), **6** 8-pack 12oz bottles (middle shelves), **17** shopping baskets (right bank)

Click the logo to return to index page ▶



H-RACKS



4x4 H-Rack

Description:

- Multi-tiered display with two 5-shelf sides and two 4-shelf sides
- Center shelves can either be flat for gravity-feed
- Promotional channel, side graphics and header options available upon request

4X4 METAL H-RACK PALLET DISPLAY (1/CTN)

Item:

4x4 H-Rack
w/ graphics

SKU:

xxx57355

Price:

\$850.00/each

Dimensions & Packout:

47.75" W x 47.75" D x 55" H (without header)

Packs out (per shelf) **48** 20oz bottles (side A), **30** 2L bottles (side B)



3x3 H-Rack

3X3 METAL H-RACK PALLET DISPLAY (1/CTN)

Item:

3x3 H-Rack
w/ graphics

SKU:

xxx57356

Price:

\$830.00*/each

*50 unit minimum

Dimensions & Packout:

36" W x 36" D x 55" H (without header)

Packs out (per shelf) **24** 20oz bottles (side A), **14** 2L bottles (side B)



2x4 H-Rack

2X4 METAL H-RACK PALLET DISPLAY (1/CTN)

Item:

2x4 H-Rack
w/ graphics

SKU:

xxx57314

Price:

\$740.00*/each

*50 unit minimum

Dimensions & Packout:

24.5" W x 48.25" D x 55" H (without header)

Packs out (per shelf) **18** 20oz bottles (side A), **12** 2L bottles (side B)

Click the logo to return to index page ▶



PRODUCE DUMP BIN

(Produce 4x4 H-rack)



Produce Dump Bin (Produce 4x4 H-Rack)

Description:

- 3 shelves on all sides
- Top vacuum formed section for merchandising fresh produce
- Center shelves can either be flat or gravity-feed
- Promotional channel, side graphics and header options available
- Ships assembled

PRODUCE DUMP BIN (1/CTN)		
Item: Produce Dump Bin	SKU: xxx57315	Price: \$910.00*/each

*50 unit minimum

Dimensions & Packout:

48" W x 48" D x 64" H (without header)
 Packs out (per shelf) **48** 20oz bottles (side A), **30** 2L bottles (side B)
 Top section packs out a variety of product (200 lb. MAX)

PROFIT TABLE CUBE ISLAND



Profit Table Cube Island

Description:

- Cross-merchandise beverages and seasonal specials near check out, electronics, video and toy departments
- Multi-tiered display with two 2-shelf sides (side A) and two 4-shelf sides (side B)
- Side A shelves can either be flat or gravity-feed and feature a removable fixed divider for 2 liter and 1 liter packaging
- Flat shelves adjustable vertically

PROFIT TABLE CUBE ISLAND (1/CTN)		
Item: Profit Table Cube Island	SKU: xxx57309	Price: \$825.00*/each

*1000 unit minimum

Dimensions & Packout:

48" W x 48" D x 55" H
 Packs out (per shelf) **54** 1.25L bottles (side A), **40** 2L bottles (side A), **25** 20oz bottles (side B), **14** 1L bottles (side B)

[Click the logo to return to index page](#) ▶



PROMO PLATFORM

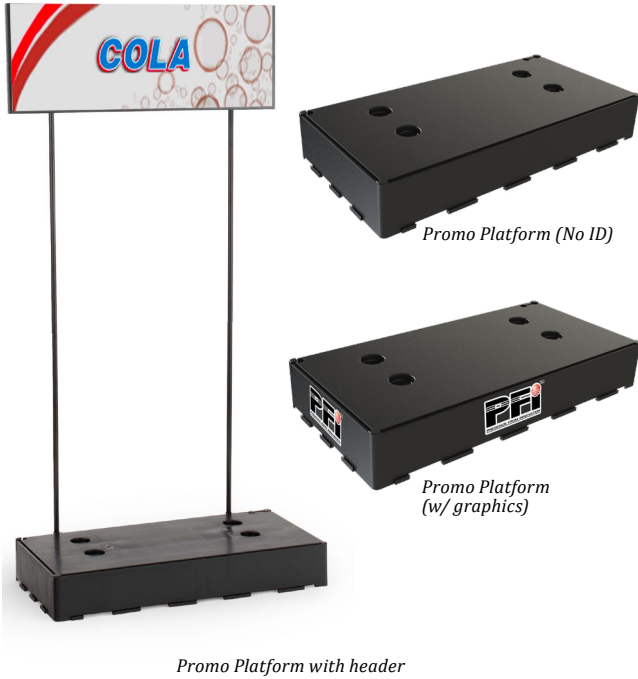

Description:

- Promo Platform is essential for merchandising bulk products off the ground in any retail channel
- Heavy duty materials allow for both indoor and outdoor use
- Connector pins allow multiple units to be connected either side-by-side or back-to-back
- Black units are made from 100% post-consumer waste
- Optional header

PROMO PLATFORM BASE & HEADER		
Item:	SKU:	Price:
Promo Platform <i>Black can base - No ID</i>	MNO44112	\$29.50/each
Promo Platform <i>Black can base - w/graphics</i>	xxx44112	\$32.50/each
Promo Platform <i>Black can base - w/graphics & header (2/ctn)</i>	xxx44112X-B	\$141.00*/ctn \$70.50/each

*250 unit minimum for header

Standard shipping is bulk packed; Up-charge of \$2.00/unit (\$4.00/ctn) possible when packaged 2/ctn.

Dimensions & Packout:

32.5" W x 16.5" D x 5" H (67.25" H with header)
Packs out (per unit) **66** 12-pack cans

ICEMAN I DUMP BIN



Description:

- Same look as our Iceman barrel coolers
- For merchandising trial and seasonal products
- Maximizes brand exposure with large graphics

ICEMAN I DUMP BIN (1/CTN)		
SKU:	Dimensions:	Price:
xxx26650	23" Dia. x 33.5" H	1-99 units..... \$89.95 100-499 units.. \$84.95 500+ units..... \$74.95

WIRE DUMP BIN



Description:

- Wire dump bin for placement in-aisle or near checkout
- Raise the level of product as it is shopped with adjustable floor

WIRE DUMP BIN (2/CTN)		
SKU:	Dimensions:	Price:
xxx57251	15" Dia. x 32" H	\$99.95 (No ID) \$107.45* (w/ graphics)

*250 unit minimum

[Click the logo to return to index page](#)



For more information or to place an order contact Customer Service: 800-325-2823
4847 Park 370 Blvd. Hazelwood, MO 63042 • PFIinnovation.com

COOL GLIDE 20/20



Description:

- Cool Glide 20/20 is the newest innovation in cold vault merchandising and incorporates market-based insights into a new design that will consistently front products
- Crystal clear product stop presents product unobstructed
- Deeper glides increase strength and packout of every shelf
- Break-off sections make the glide easy to configure
- Graphic and pricing channels incorporated into every shelf
- Individual tracks can be quickly connected to merchandise different size bottles on the same shelf
- Extra tracks can be connected and disconnected without damaging the glide

For 20oz bottles



For 12oz & 16oz cans



For 1L & 28oz bottles



COOL GLIDE 20/20 9-WIDE (6/CTN)		
Item:	SKU:	Price:
Cool Glide 20/20 9-W Standard Depth	MNO12202	\$149.70/ctn \$24.95/each
Cool Glide 20/20 9-W Extended Depth	MNO12202-36PC	\$227.70/ctn \$37.95/each

COOL GLIDE 20/20 10-WIDE (6/CTN)		
Item:	SKU:	Price:
Cool Glide 20/20 10-W Standard Depth	MNO12210	\$149.70/ctn \$24.95/each
Cool Glide 20/20 10-W Extended Depth	MNO12210-36PC	\$227.70/ctn \$37.95/each

COOL GLIDE 20/20 8-WIDE (6/CTN)		
Item:	SKU:	Price:
Cool Glide 20/20 8-W Standard Depth	MNO12212	\$149.70/ctn \$24.95/each
Cool Glide 20/20 8-W Extended Depth	MNO12212-36PC	\$227.70/ctn \$37.95/each

Dimensions & Packout:

28.5" W x 28" D (Extended Depth: 36" D)
Standard depth packs out **81** 20oz bottles
Extended depth packs out **108** 20oz bottles

Dimensions & Packout:

28.5" W x 28" D (Extended Depth: 36" D)
Standard depth packs out **100** 12oz & 16oz cans/bottles
Extended depth packs out **130** 12oz & 16oz cans/bottles

Dimensions & Packout:

28.5" W x 29" D (Extended Depth: 37" D)
Standard depth packs out **64** 1L bottles and 28oz bottles
Extended depth packs out **80** 1L bottles and 28oz bottles

For 32oz bottles



For 12oz slim cans



COOL GLIDE 20/20 7-WIDE (6/CTN)		
Item:	SKU:	Price:
Cool Glide 20/20 7-W Standard Depth	MNO12232	\$149.70/ctn \$24.95/each
Cool Glide 20/20 7-W Extended Depth	MNO12232-36PC	\$227.70/ctn \$37.95/each

Dimensions & Packout:

28" W x 28" D (Extended Depth: 36" D)
Standard depth packs out **49** 32oz bottles
Extended depth packs out **63** 32oz bottles

COOL GLIDE 20/20 11-WIDE (6/CTN)		
Item:	SKU:	Price:
Cool Glide 20/20 11-W Standard Depth	MNO12211	\$149.70/ctn \$24.95/each
Cool Glide 20/20 11-W Extended Depth	MNO12211-36PC	\$227.70/ctn \$37.95/each

Dimensions & Packout:

28" W x 29" D (Extended Depth: 36" D)
Standard depth packs out **121** 12oz slim cans
Extended depth packs out **165** 12oz slim cans

+ Add graphics to Cool Glide 20/20 for additional \$1.00 (120 unit minimum)

[Click the logo to return to index page](#)



INTELLI-GLIDE



Intelli-Glide

Description:

- Gravity-feed problematic packages with one consistent look across your cooler doors
- Adjustable dividers allows for merchandising different package sizes on a single shelf
- Multiple divider-floor connectivity points prevent dividers from playing
- Patented clear front product stop available in three heights + price cap
- Perfect for single serve and multi-packs on one shelf
- Ships unassembled
- Ask for the Intelli-Glide packout matrix

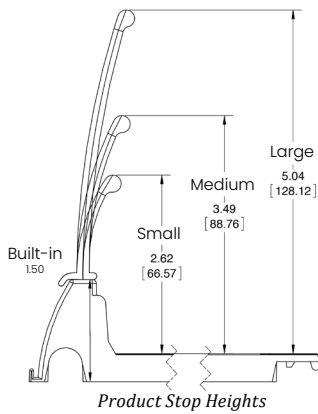

Product Stop Heights

INTELLI-SYSTEM (6/CTN)*		
Item:	SKU:	Price:
Intelli-Glide Standard Depth	Various	\$197.70/ctn \$32.95/each
Intelli-Glide Extended Depth	Various	\$278.70/ctn \$46.45/each

*All prices unassembled

Dimensions:

28.5" W x 26" D (Extended Depth: 36"D)

MODULAR GLIDE

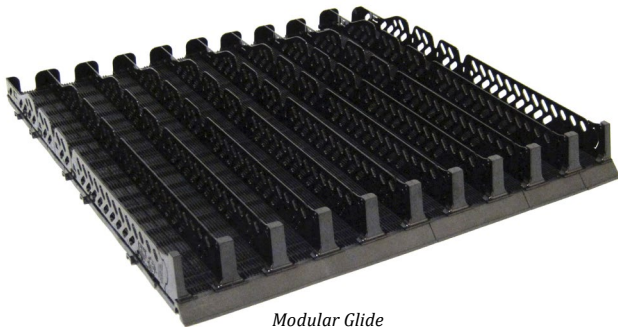

Modular Glide

Description:

- Modular floor sections and adjustable dividers create a perfect solution for when you can't fill an entire shelf
- Shallower floor depths (17", 20" and 23") can be created by snapping off floor sections in one of three locations
- Product stops are attached to dividers for ease of reconfiguring pack-outs
- Ships unassembled



Modular Glide shown separated

MODULAR GLIDE (6/CTN)*		
Item:	SKU:	Price:
Modular Glide Standard Depth	Various	\$201.00/ctn \$33.50/each
Modular Glide Extended Depth	Various	\$287.70/ctn \$47.95/each

*All prices unassembled

Dimensions:

28.5" W x 26" D (Extended Depth: 36"D)

Click the logo to return to index page ▶



CAN ROLLER



Adjustable Can Roller
Standard Depth

Description:

- Maximize space in cold vault coolers with this flexible solution
- Gain incremental facings for test products
- Gravity feed single serve drinks
- Features adjustable dividers and graphic channels

ADJUSTABLE CAN ROLLERS (1/CTN)		
Item:	SKU:	Price:
A. Adjustable Can Roller Standard Depth	MNO13951-17	\$62.95 (No ID) \$64.45 (w/ graphics*)
B. Adjustable Can Roller Extended Depth	MNO13952-17	\$68.55 (No ID) \$70.05 (w/ graphics*)
*120 unit minimum		

Dimensions & Packout:

- A:** 26.25" W x 32" D
Packs out (per unit) **30** 24oz cans, **33** 16oz cans, **55** 12oz cans, **39** 12oz slim cans
- B:** 26.25" W x 40" D
Packs out (per unit) **36** 24oz cans, **60** 16oz cans, **70** 12oz cans, **51** 12oz slim cans

+ Add graphics to Can Rollers for additional \$1.50 (120 unit minimum)

SPACEMAKER



Spacemaker



Modular Spacemaker

Description:

- Insert an additional shelf to gain vertical space in your existing cold vault
- One additional shelf adds approximately 110 cans on a 26" deep shelf
- Ability to adjust width and depth

SPACEMAKERS		
Item:	SKU:	Price:
A. Spacemaker (6/ctn)	MNO13900	\$255.00/ctn \$42.50/each
B. Extended Depth Spacemaker Grid (1/ctn)	MNO13936	\$101.50* /ctn
C. Modular Spacemaker (6/ctn)	MNO13920	\$255.00/ctn \$42.50/each
*100 unit minimum		

Dimensions:

- A:** 21" W - 28.5" W x 21" D
B: 21" W - 28.5" W x 36" D
C: 21" W - 28.5" W x 26" D

Click the logo to return to index page ▶



ULTRA-GLIDE



Description:

- Convert flat gondola shelving to gravity-feed
- Easy to use! Simply place the Ultra-Glide onto the gondola shelf and insert gravity-feed floors
- Feature fixed 2 liter dividers
- Extend the life of your ultra-glide by ordering replacement floors as needed

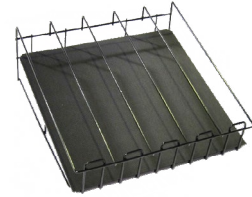
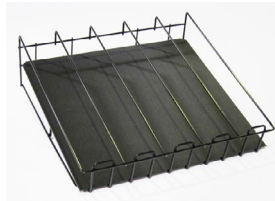

ULTRA-GLIDE 2' X 4 DEEP (4/CTN)		
Item:	SKU:	Price:
Ultra-Glide 2' x 4 Deep - Beige	MNO51724	\$347.80/ctn \$86.95/each
Ultra-Glide 2' x 4 Deep - Black	MNO51724-BLK	\$347.80/ctn \$86.95/each

ULTRA-GLIDE 2' X 5 DEEP (4/CTN)		
Item:	SKU:	Price:
Ultra-Glide 2' x 5 Deep - Beige	MNO51725	\$365.40/ctn \$91.35/each
Ultra-Glide 2' x 5 Deep - Black	MNO51725-BLK	\$365.40/ctn \$91.35/each

ULTRA-GLIDE 2' X 6 DEEP* (4/CTN)		
Item:	SKU:	Price:
Ultra-Glide 2' x 6 Deep - Beige	MNO51726	\$487.80/ctn \$121.95/each
Ultra-Glide 2' x 6 Deep - Black	MNO51726-BLK	\$487.80/ctn \$121.95/each

Dimensions & Packout:
24" W x 19.25" D x 5.3" H
Packs out (per unit) **20** 2L bottles

Dimensions & Packout:
24" W x 22.5" D x 5.3" H
Packs out (per unit) **20** 2L bottles

Dimensions & Packout:
24" W x 28" D x 5.3" H
Packs out (per unit) **30** 2L bottles

**100 unit minimum*

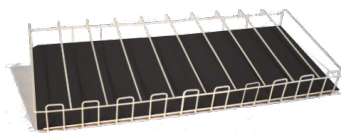

ULTRA-GLIDE 4' X 4 DEEP (2/CTN)		
Item:	SKU:	Price:
Ultra-Glide 4' x 4 Deep - Beige	MNO51735	\$345.40/ctn \$172.70/each
Ultra-Glide 4' x 4 Deep - Black	MNO51735-BLK	\$345.40/ctn \$172.70/each

ULTRA-GLIDE 4' X 5 DEEP (2/CTN)		
Item:	SKU:	Price:
Ultra-Glide 4' x 5 Deep - Beige	MNO51730	\$359.80/ctn \$179.90/each
Ultra-Glide 4' x 5 Deep - Black	MNO51730-BLK	\$359.80/ctn \$179.90/each

ULTRA-GLIDE 3' X 5 DEEP (2/CTN)		
Item:	SKU:	Price:
Ultra-Glide 3' x 5 Deep - Beige	MNO51731	\$343.90/ctn \$171.95/each
Ultra-Glide 3' x 5 Deep - Black	MNO51731-BLK	\$343.90/ctn \$171.95/each

Dimensions & Packout:
47.75" W x 19.25" D x 5.3" H
Packs out (per unit) **40** 2L bottles

Dimensions & Packout:
47.75" W x 22.5" D x 5.3" H
Packs out (per unit) **50** 2L bottles

Dimensions & Packout:
36" W x 22.5" D x 5.3" H
Packs out (per unit) **35** 2L bottles

REPLACEMENT FLOORS

Item:	SKU:	Price:	Item:	SKU:	Price:
Ultra-Glide 2' x 4 Deep Replacement Floor (15/ctn)	MNO50024	\$285.00/ctn \$19.00/each	Ultra-Glide 4' x 4 Deep Replacement Floor (1/ctn)	MNO50024	\$38.00/each
Ultra-Glide 2' x 5 Deep Replacement Floor (15/ctn)	MNO50025	\$315.00/ctn \$21.00/each	Ultra-Glide 4' x 5 Deep Replacement Floor (5/ctn)	UG01-2809-1-BLK	\$42.00/each
Ultra-Glide 2' x 6 Deep Replacement Floor (15/ctn)	MNO50026	\$345.00/ctn \$23.00/each			

Click the logo to return to index page ▶



SUPER ULTRA-GLIDE



Super Ultra-Glide

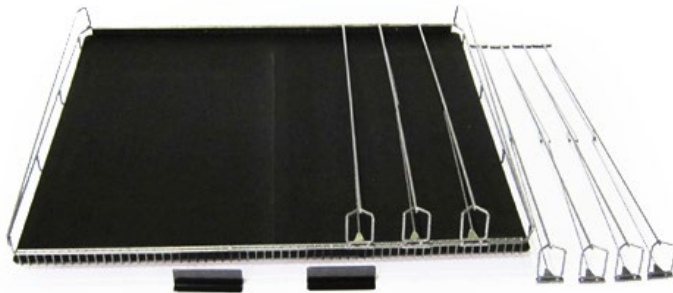

Adjustable Super Ultra-Glide

Description:

- 2 versions available:
 - Super Ultra-Glide - features fixed 2L dividers
 - Adjustable Super Ultra-Glide - features adjustable dividers that can also function as product stops when reversed
- Convert flat gondola shelving to gravity-feed
- Easy to use! Simply place the Ultra-Glide onto the gondola shelf and insert gravity-feed floors
- Extend the life of your ultra-glide by ordering replacement floors as needed

SUPER ULTRA-GLIDES (1/CTN)

Item:	SKU:	Price:
Super Ultra-Glide 4' x 9' Deep - Beige	MNO51760	\$229.00/each
Super Ultra-Glide 4' x 9' Deep - Black	MNO51760-BLK	\$229.00/each
Adjustable Super Ultra-Glide Beige	MNO51750	\$250.00*/each
Adjustable Super Ultra-Glide Black	MNO51750-BLK	\$250.00*/each

*100 unit minimum

Dimensions & Packout:

47" W x 40" D x 5.5" H
Packs out **90** 2L bottles

REPLACEMENT FLOOR (1/CTN)

Item:	SKU:	Price:
Super Ultra-Glide Replacement Floor	UG01-2812-BLK	\$57.00/each

[Click the logo to return to index page](#) ▶



PET RECYCLE BOTTLE



PET Recycle Bottle

Description:

- Our recyclable is ideal for use at large venue locations such as stadiums, theme parks, theaters, promotional events and more
- Custom graphics display your brand's eco-friendly advocacy
- Withstands extreme weather conditions
- Constructed from durable, 100% post-consumer plastic waste (black version only)

PET RECYCLE BOTTLE (1/CTN OR BULK PACKED)		
Item: PET Recycle Bottle	SKU: GEN47100	Price: \$129.95/each

Dimensions:

19.75" Dia. x 56.75" H

ACCESSORIES FOR PET RECYCLE BOTTLE (1/CTN)		
Item: PET Recycle Bin Weight Base	SKU: MNO47900	Price: \$19.95/each

REPLACEMENT GRAPHICS (BULK PACKED)		
Item: PET Recycle Bin Replacement Graphics	SKU: MNO47900	Price: 1-149 units..... \$25.00 150+ units..... \$21.50



Weight Base



Replacement Graphics

[Click the logo to return to index page](#) ▶



SHOWOFF SPECTACTULAR



Description:

- The Showoff Spectacular is our Showoff III Plastic Rack with a corrugated sleeve i.e. Spectacular Graphic Sleeve that can be changed out multiple times throughout the year to go with promotions and more!
- Spectacular graphic sleeve can be removed - all while leaving a permanent display solution in the market
- The Showoff Spectacular increases customer awareness with an eye-catching appearance that differentiates it from traditional displays

SHOWOFF SPECTACTULAR GRAPHIC SLEEVE	
QTY:	Price:
250-499	\$85.10/each
500-999	\$57.10/each
1,000+	\$42.50/each

See page 22 for Showoff III pricing

ACCESSORIES FOR SHOWOFF SPECTACTULAR	
Item:	Price:
Mop Tray	\$11.70/each



Dimensions:

SPECTACTULAR GRAPHIC SLEEVE:
19.25" W x 19.25" D x approx. 62" H
See page 20 for Showoff III dimensions

3-SHELF CASE RACK 15" W (no dividers)



15" 3-Shelf Case Rack

Description:

- Corrugated 3-Shelf Case Rack

3-CASE SHELF RACK	
QTY:	Price:
100	\$159.50/each
250	\$89.60/each
500	\$62.10/each
1000	\$40.80/each
1500	\$34.20/each
2000	\$32.20/each
2500	\$31.20/each

Dimensions & Packout:

Up to 15" W x 13.25" D x 51" H
+ 14.5" header
Packs out **6** 2L bottlers per shelf

Dimensions are for reference; can be customized to fit most product and package sizes

3-SHELF CASE RACK 20" W (no dividers)



20" 3-Shelf Case Rack

Description:

- Corrugated 3-Shelf Case Rack

3-CASE SHELF RACK	
QTY:	Price:
100	\$164.50/each
250	\$93.00/each
500	\$65.50/each
1000	\$42.70/each
1500	\$36.80/each
2000	\$34.70/each
2500	\$33.30/each

Dimensions & Packout:

Up to 20" W x 13.25" D x 51" H
+ 14.5" header
Packs out **8** 7.5oz 6pks per shelf

Dimensions are for reference; can be customized to fit most product and package sizes

Click the logo to return to index page >



4-SHELF CASE RACK 15" W (no dividers)



15" 4-Shelf Case Rack

Description:

- Corrugated 4-Shelf Case Rack

4-CASE SHELF RACK

QTY:

100
250
500
1000
1500
2000
2500

Price:

\$163.20/each
\$94.10/each
\$65.30/each
\$43.60/each
\$37.40/each
\$35.40/each
\$33.80/each

Dimensions & Packout:

Up to 15" W x 13.25" D x 51" H + 14.5" header
Packs out **6** 2L bottlers per shelf

Dimensions are for reference; can be customized to fit most product and package sizes

4-SHELF CASE RACK 20" W (no dividers)



20" 4-Shelf Case Rack

Description:

- Corrugated 3-Shelf Case Rack

4-CASE SHELF RACK

QTY:

100
250
500
1000
1500
2000
2500

Price:

\$179.60/each
\$101.70/each
\$66.40/each
\$44.40/each
\$39.40/each
\$37.30/each
\$36.00/each

Dimensions & Packout:

Up to 20" W x 13.25" D x 51" H + 14.5" header
Packs out **8** 7.5oz 6pk per shelf

Dimensions are for reference; can be customized to fit most product and package sizes

3 CASE MERCHANDISER SLEEVE



3 Case Merchandiser Sleeve

Description:

- One case on top with two product cases supporting within sleeve

3 CASE MERCHANDISER SLEEVE

QTY:

100
250
500
1000
1500
2000
2500

Price:

\$58.60/each
\$36.90/each
\$24.50/each
\$17.40/each
\$14.60/each
\$13.60/each
\$13.10/each

Dimensions:

13.5" W x 9.75" D x 37.75" H

Dimensions are for reference; can be customized to fit most product and package sizes

4 CASE MERCHANDISER SLEEVE



4 Case Merchandiser Sleeve

Description:

- One case on top with three product cases supporting within sleeve

4 CASE MERCHANDISER SLEEVE

QTY:

100
250
500
1000
1500
2000
2500

Price:

\$65.90/each
\$40.20/each
\$27.00/each
\$20.10/each
\$17.30/each
\$16.30/each
\$15.40/each

Dimensions:

13.5" W x 9.75" D x 48" H

Dimensions are for reference; can be customized to fit most product and package sizes

[Click the logo to return to index page](#)



ONE CASE BIN



One Case Bin

Description:

- Platform for one case of product with supporting structure beneath

ONE CASE BIN	
QTY:	Price:
100	\$87.00/each
250	\$49.40/each
500	\$33.10/each
1000	\$23.30/each
1500	\$20.60/each
2000	\$18.80/each
2500	\$18.10/each

Dimensions:

19.5" W x 14.625" D x 41" H
 Dimensions are for reference; can be customized to fit most product and package sizes

2 SECTION DUMP BIN



2-Section Dump Bin

Description:

- Platform for one case of product with supporting structure beneath

2-SECTION DUMP BIN	
QTY:	Price:
100	\$174.50/each
250	\$87.80/each
500	\$58.50/each
1000	\$42.00/each
1500	\$36.70/each
2000	\$34.80/each
2500	\$33.60/each

Dimensions:

22" W x 17" D x 38.25" H
 Dimensions are for reference; can be customized to fit most product and package sizes

CASE STACKER



Case Stacker

Description:

- Bulk product merchandiser meant for stacking cases

CALL FOR A QUOTE

Dimensions:

20.75" W x 14.5" D x 46.5" H
 Dimensions are for reference; can be customized to fit most product and package sizes

RETAIL STANDEE



Retail Standee

Description:

- One-sided stand up with easel structure on back

RETAIL STANDEE	
QTY:	Price:
100	\$73.20/each
250	\$43.80/each
500	\$28.60/each
1000	\$19.90/each
1500	\$16.70/each
2000	\$15.60/each
2500	\$14.20/each

Dimensions:

Up to 36" W x 72" H
 Dimensions are for reference; can be customized to fit most product and package sizes

Ask us about our custom solutions!



Click the logo to return to index page ▶

SUCTION CUP COOLER DOOR RACKS



Description:

- Cooler door displays for beverages and more
- Suction cups provide secure hold up to 12 lbs and can withstand door swinging
- Made from break-resistant Polycarbonate
- Hi-Vis Beverage Displays for cans, bottles and similar sized packages
- Hi-Vis Specialty Displays for variety of products including: beef jerky, egg cartons, candy, ice cream etc.
- Made in U.S.A.

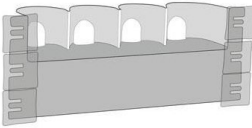
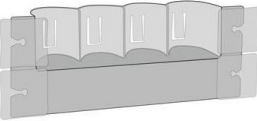
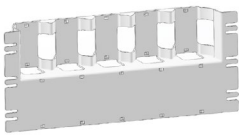
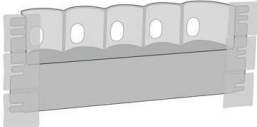
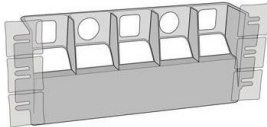
Image	Unit	Dimensions	Package	Price
BEVERAGE RACKS				
	HVB-4 10/ctn	Rack Dimensions: 15.9" W x 3.5" D x 5.9" H Label Area: 13.75" W x 2.5" H Diameter for Product: 3.25"	(4) 32 oz cans	\$230.00/ctn \$23.00/each
	HVB-4S 10/ctn	Rack Dimensions: 11.5" W x 2.2"D x 4.5" H Label Area: 9.75" W x 1.75" H Diameterfor Product: 2.125"	(4) 8 oz slim cans	\$230.00/ctn \$23.00/each
	HVB-5A 10/ctn	Rack Dimensions: 17.2" W x 2.8" D x 7" H Label Area: 14.5" W x 2.75" H Diameter for Product: 2.87"	(5) 20oz bottles, (5) 24oz cans	\$230.00/ctn \$23.00/each
	HVB-5B 10/ctn	Rack Dimensions: 11.5" W x 2.2"D x 4.5" H Label Area: 9.75" W x 1.75" H Diameterfor Product: 2.125"	(5) 16 oz cans	\$230.00/ctn \$23.00/each
	HVB-5D 10/ctn	Rack Dimensions: 15.8" W x 2.6" D x 6.2" H Label Area: 13.5" W x 2.5" H Diameter for Product: 2.65"	(5) 16 oz square bottles, (5) 16 oz cans	\$230.00/ctn \$23.00/each

[Click the logo to return to index page](#) ▶



SUCTION CUP COOLER DOOR RACKS

Image	Unit	Dimensions	Packout	Price
	HVB-6A 10/ctn	Rack Dimensions: 19.9" W x 2.9" D x 5.9" H Label Area: 17.5" W x 2.5" H Diameter for Product: 3.06"	(6) pieces	\$230.00/ctn \$23.00/each
	HVB-6B 10/ctn	Rack Dimensions: 17.4" W x 2.4" D x 5.5" H Label Area: 15.5" W x 2.25" H Diameter for Product: 2.375"	(6) 10 oz cans, (6) 200 mL bottles	\$230.00/ctn \$23.00/each
	HVB-6C 10/ctn	Rack Dimensions: 16.9" W x 2.2" D x 5.5" H Label Area: 14.75" W x 2.5" H Diameter for Product: 2.33"	(6) 12 oz slim cans	\$230.00/ctn \$23.00/each
	HVB-6D 10/ctn	Rack Dimensions: 19.2" W x 5.8" H x 2.6" D Label Area: 15.8" W x 2.5" H Diameter for Product: 2.6"	(6) 16oz cans	\$230.00/ctn \$23.00/each
	HVB-7 12/ctn	Rack Dimensions: 18.1" W x 2.2" D x 4" H Label Area: 16" W x 1.75" H Diameter for Product: 2.25"	(7) 8.4 oz–10 oz cans	\$276.00/ctn \$23.00/each
	HVB-8B 12/ctn	Rack Dimensions: 17" W x 1.6" D x 5" H Label Area: 15" W x 2" H Diameter for Product: 1.8"	(8) plastic specialty bottle	\$276.00/ctn \$23.00/each
	HVB-8C 12/ctn	Rack Dimensions: 15" W x 1.4" D x 5" H Label Area: 12.75" W x 2" H Diameter for Product: 1.525"	(8) 2oz–3oz bottles	\$276.00/ctn \$23.00/each
	HVV-5A 10/ctn	Rack Dimensions: 14.2" W x 3" D x 24.8" H Label Area: 5.5" W x 3.25" H Diameter for Product: 2.9"	(8) 2oz–3oz bottles	\$230.00/ctn \$23.00/each

[Click the logo to return to index page](#) ▶



SUCTION CUP COOLER DOOR RACKS

Image	Unit	Dimensions	Package	Price
	HVV-5B 10/ctn	Rack Dimensions: 5.9" W x 2.4" D x 21" H Label Area: 5.5" W x 3" H Diameter for Product: 2.62"	(5) 16 oz cans	\$230.00/ctn \$23.00/each
	HVV-8A 8/ctn	Rack Dimensions: 7.2" W x 2.7" D x 24" H Label Area: 4.625" W x 3.75" H Diameter for Product: 2.818" x 2.818"	(8) tetra single serve containers	\$184.00/ctn \$23.00/each
	HVV-8C 6/ctn	Rack Dimensions: 7.25" W x 2.3" D x 22" H Label Area: 4.5" W x 6" H Diameter for Product: 2.25"	(8) 12 oz slim cans	\$138.00/ctn \$23.00/each
GROCERY/SPECIALTY RACKS				
	HVO-4 10/ctn	Rack Dimensions: 20.2" W x 4.6" D x 6.1" H Label Area: 17.25" W x 2.25" H Diameter for Products: 4.288" x 3.989"	(8) bottles (chocolate syrup, ketchup, etc.)	\$230.00/ctn \$23.00/each
	HVS-6 10/ctn	Rack Dimensions: 8" W 3" D 5.6" H Label Area: 7.5" W 1.25" H Diameter for Product: 3" x 6.25"	multi-purpose specialty packages	\$230.00/ctn \$23.00/each
	HVL-9 8/ctn	Rack Dimensions: 11.2" W x 5.9" D x 5.7" H Label Area: 9.5" W x 1.75" H Diameter for Product: 4.707" x 8.75"	multi-purpose packaging	\$184.00/ctn \$23.00/each
	HVL-16 10/ctn	Rack Dimensions: 18.2" W x 4.3" D x 5.9" H Label Area: 16.5" W x 1.75" H Diameter for Product: 3.75" D x 16.5" W	multi-purpose packaging	\$230.00/ctn \$23.00/each

[Click the logo to return to index page](#) ▶

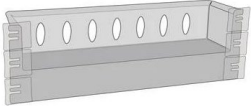
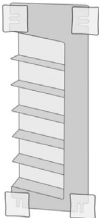

SUCTION CUP COOLER DOOR RACKS

Image	Unit	Dimensions	Package	Price
	HVL-18 10/ctn	Rack Dimensions: 20.5" W x 4.7" D x 6.5" H Label Area: 17.5" W x 2" H Diameter for Product: 4.35" D x 17" W	multi-purpose packaging	\$230.00/ctn \$23.00/each
	HVL-19 10/ctn	Rack Dimensions: 20.6" W x 4.5" D x 6.4" H Label Area: 18.5" W x 2.25" H Diameter for Product: 4" x 18.25"	(6) 10 oz cans, (6) 200 mL bottles	\$230.00/ctn \$23.00/each
	HVA-6B 6/ctn	Rack Dimensions: 6.7" W x 2.8" D x 18.5" H Small Top Label Area: 4.5" W X 2.25" H Long Side Label Area: 14.5" W x 1.75" H Diameter for Product: 2.25"	(6) egg crates	\$138.00/ctn \$23.00/each

[Click the logo to return to index page](#) ▶



C21 COOLER SHELVING SYSTEM



C21 shown in cooler door



New C21 Shelf

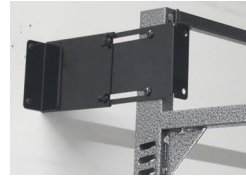

Optional Wall Bracket



Numbered Uprights

Description:

- The C21 Cooler Shelving System is the premium shelving system for the walk-in cooler -- features easily adjustable shelves that maximize the space in the cold vault
- Now even easier to use! Innovative spring-loaded levers allow for one individual to reposition fully loaded shelves
- Reduces wasted space
- Shelves feature structural crossbars for extra strength
- Greater product visibility - The C21 does not need to be mounted to a wall, allowing the unit to be more accurately positioned in alignment with cooler lighting

C21 COOLER SHELVING SYSTEM (1/CTN)		
Item: Cooler 21	SKU: Multiple SKUs	Price: Call for Quote

Dimensions:

Varies



STOCKMASTER



Description:

- Complete inventory management system that allows retailers to take control of the walk-in cooler. Organize and manage full and partial cases in an organized, safe environment.
- 2 Versions available:
 - **Stockmaster** - 18" rear stationary cart depth
 - **Stockmaster Plus** - 24" rear stationary section depth
- Rear stationary sections create a location for full cases to be stored off the ground before they get transferred forward for product staging
- Front mobile section manages broken and partial cases creating easy access to load glides for consumer sales

STOCKMASTER (1/CTN)		
Item: Stockmaster	SKU: Multiple SKUs	Price: Call for Quote
Item: Stockmaster Plus	SKU: Multiple SKUs	Price: Call for Quote

Dimensions:

Varies

[Click the logo to return to index page](#) ▶



For more information or to place an order contact Customer Service: 800-325-2823
4847 Park 370 Blvd. Hazelwood, MO 63042 • PFIinnovation.com

RETAIL SHELVING



Description:

- Walk-in cooler open shelving preserves product temperature
- Add as many shelves to accommodate inventory needs
- Manage stockroom surplus in constrained spaces
- Defies warped shelving - performance, durability & reliability tested
- Shared uprights conserve space and costs

RETAIL SHELVING (1/CTN)		
Item: Retail Shelving	SKU: Multiple SKUs	Price: Call for Quote

Dimensions:

Widths available: 24", 36" and 48"
 Depths available: 24" and 36"
 Heights available: 65"



BAG-IN-BOX STOCKMASTER



Description:

- Organize bag-in-box deliveries
- Angled shelves are vertically adjustable to accommodate any bag-in-box size
- Mobile cart transfers syrup concentrates from inventory to fountain dispensers

BAG-IN-BOX STOCKMASTER (1/CTN)		
SKU: MNO52600-A	Dimensions: 40.75" W x 36.25" D x 70.25" H	Pricing: Call for Quote

STOCKMASTER IMC CART



Description:

- Control overflow inventory of single serve bottles and cans in your walk-in cooler
- Mobility allows unit to be moved throughout the walk-in cooler and sales floor
- Shelves are vertically adjustable

STOCKMASTER IMC CART (1/CTN)		
SKU: MNO52400	Dimensions: 39.75" W x 17.5" D x 72.75" H	Pricing: Call for Quote

Click the logo to return to index page ▶



RBC SHELVING



Description:

- Shelving solution for walk-in coolers, beer caves, storage areas and retail.
 - Use in beer cave to make heavy cases of beer easily accessible to customers.
 - Use in storage areas for static back room shelving.
- Corner sections eliminate unusable dead space and create more merchandising options.
- Shared uprights conserve space and enhance flow between units.
 - Shelves independently adjustable even with shared uprights.
- Shelves can be set to flat or gravity-feed for more merchandising options.
- Shelving rated to support up to 600 lbs. per shelf
- Crossbars can be reversed for positioning product higher off the floor.
- Price channels included on every shelf to promote brand and price promotions. Price channels can be reversed for flush fit or as a product stop.

RBC SHELVING (1/CTN)

Item:
RBC Shelving

SKU:
Multiple SKUs

Price:
Call for Quote

Dimensions:

- SHELF WIDTHS AVAILABLE: 36" W & 48" W
- SHELF DEPTHS AVAILABLE: 18" D & 24" D
- HEIGHTS AVAILABLE: 60" H & 72" H



